

A Performance of Photovoltaic Generator

¹Eman Abdelsalam Garmoud and ²Amal Jamal Boukar

Tripoli University, Faculty of Education - Janzour
Tripoli- Libya

¹E-mail EA.phy2017@gmail.com

²E-mail amal_boukar@yahoo.com

Abstract—Photovoltaic Generators are important generators for the application of renewable energy sources because of the direct conversion of solar energy to electric energy. They have some advantages such as low weight and feasibility of small scales, but they are more expensive compared to other types of energy converters. Therefore, it is important to absorb the output power of the system.

This paper describes a method of modeling and simulation photovoltaic (PV) module that implemented in Simulink/Matlab, using a different DC-AC converter efficiency varying from 80%, 90% and 98% and getting the result of the output AC power, also Solar panels varies during the test to experiment the effect of adding more solar panels while the DC-AC converter efficiency is assumed to be a fixed 98 percent.

Keywords—DC-AC converter ; Photovoltaic; solar panel; efficiency;

I. INTRODUCTION

Solar energy is one type of the renewable energy sources which can be converted easily and directly to the electric energy by Photovoltaic Generators. The process of no movable mechanisms to convert solar energy to electric energy is called photovoltaic phenomena whereas the conversion device is called solar panel [1].

Solar panel convert the energy of light's photons to electric energy with efficiency between 5 to 25 percent without using thermodynamic cycle or active fluid. And it can be light collector directly or can use a light concentrators like mirror or convex lens.

The photovoltaic Generators is a developed energy Generators with the advantages such as: relevant design and installation, silent energy conversion, long life time with less maintenance

requirement, easy transportation and light weight. But in compare with other types of energy converters like diesel generator it is more expensive. Therefore, the DC-AC converter efficiency and the number of solar cells are important factors [1,2].

In this paper, an implementations of a photovoltaic generator model that can be used to simulate performance using historical irradiance data. Here the model is tested by varying the DC-AC converter efficiency. Power generation steps immediately following the efficiency change. And the model is also tested by by varying the numbers of solar panels while the DC-AC converter efficiency is assumed to be a fixed 98 percent.

II. MODELING OF THE PHOTOVOLTAIC SYSTEM

A photovoltaic generator is the whole assembly of solar cells, connections, protective parts, supports etc. In the present modeling, the focus is only on DC-AC converters efficiency, and the number of solar panels.

The components of the Photovoltaic Generator Model

1. The solar panel - The block represents a single solar cell as a parallel combination of a current source, two exponential diodes and a parallel resistor, R_p , that are connected in series with a resistance R_s , The following figure shows the equivalent circuit diagram for the solar cell that had been used in this model:[3]

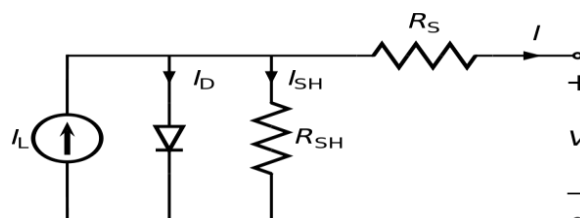

Fig 1 the equivalent circuit of a solar cell

The output current I is given by

$$I = I_{ph} - I_s * \left(e^{\frac{V+I*R_s}{N*V_t}} - 1 \right) - I_{s2} * \left(e^{\frac{V+I*R_s}{N_2*V_t}} - 1 \right) - (V + I * R_s) / R_p \quad (1)$$

Where Is and Is2 are the diode saturation currents, Vt is the thermal voltage, N and N2 are the quality factors (diode emission coefficients) and Iph is the solar-generated current.

Models of reduced complexity can be specified in the mask. The quality factor varies for amorphous cells, and typically has a value in the range of 1 to 2. The physical signal input Ir is the irradiance (light intensity) in W/m² falling on the cell. The solar-generated current Iph is given by Ir*(Iph0/Ir0) where Iph0 is the measured solar-generated current for irradiance Ir0.

2. The DC-AC Converter - it's a combination of an ideal current sensor which converts current measured in any electrical branch into a physical signal proportional to the current, and also the DC-AC converters consists a controlled voltage source which represents an ideal voltage source that is powerful enough to maintain the specified voltage at its output regardless of the current passing through it. The output voltage is V = Vs, where Vs is the numerical value presented at the physical signal port, and at last the DC-AC PS Gain, This block multiplies the input physical signal by a constant which

is the efficiency of the DC-AC Converter.

3. Radiative Heat Transfer - The block represents an energy transfer by radiation between two surfaces. The transfer is governed by the Stefan-Boltzmann law and is directly proportional to the area, the radiation coefficient, and the difference of the forth powers of body temperatures.

The radiation coefficient depends on the configuration properties and emissivity of interacting bodies.

4. Convective Heat Transfer- The block represents an energy transfer by convection between two bodies by means of fluid motion. The transfer is governed by the Newton law of cooling and is directly proportional to the convection heat transfer coefficient, surface area, and the temperature difference.

5. PS Lookup Table (2D) - This block represents a physical signal converter whose input-output relationship is specified by a two-dimensional lookup table. The two table grid vectors define a Cartesian grid in 2D space. Each of the two table grid vectors must be in strictly ascending or strictly descending order, but the spacing can be nonuniform, the optimal operating point of this block is where the power versus voltage curve for current irradiance level and temperature reaches a peak. The tabulated data used here is generated from a polynomial surface fit to data obtained by running the elec_solar_characteristics_callback.m script used by the Solar Cell Power Curve example model.

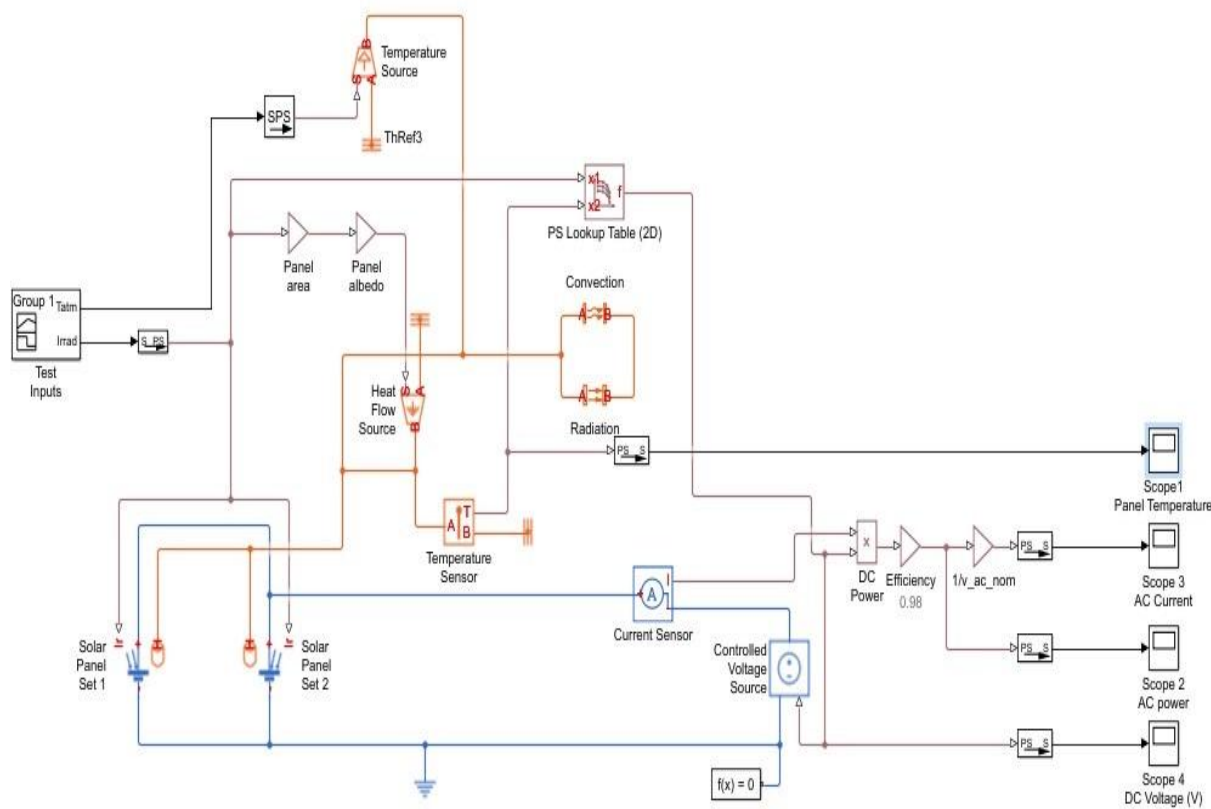

Fig 2 Photovoltaic Generator Model

6. An Ideal Heat Flow Source- The block represents an ideal source of thermal energy that is powerful enough to maintain specified heat flow at its outlet regardless of the temperature difference across the source.

7. An Ideal Temperature Sensor - The block represents a device that determines the temperature differential measured between two points without drawing any heat

8. An Ideal Temperature Source - The block represents an ideal source of thermal energy that is powerful enough to maintain specified temperature at its outlet regardless of the heat flow consumed by the system. The temperature differential across the source is directly proportional to the control signal.

9. Thermal Reference - The block represents a thermal reference point, that is, a point with a zero or constant temperature, with respect to which all the temperatures in the system are determined.

10. PS Simulink Converters - Converts the unit less Simulink input signal to a Physical Signal, The unit expression in 'Input signal unit' parameter is associated with the unit less Simulink input signal and determines the unit assigned to the Physical Signal.

11. Scope - The Simulink Scope block displays the generated time domain signals with respect to simulation time.

III. IMPLEMENT AND SIMULATE THE PHOTOVOLTAIC GENERATER

There are several things that effects the output power of the Photovoltaic generator and in this paper the focus would be on the effect of changing the DC-AC Converter gain which is the efficiency of the converter and how it effect on the output AC power of the system, and in another test will see what would happens to the output AC power of the system by adding more solar panels to the system.

The experiment duration time would be 30 min, so we will get a results for a period of 1800 seconds.

A. DC-AC Converter Efficiency

The PV module was implemented using a Matlab program. The model parameters are evaluated during execution using the listed parameters:

1. DC-AC converter Efficiency 80%
2. DC-AC converter Efficiency 90%
3. DC-AC converter Efficiency 98%

By varying the PS gain which is the efficiency of the converter we can get three different results, while on the other hand the Solar panels would be fixed in two solar panels.

B. The number of solar pan

The other test is to change the number of the solar cells of the PV model, by adding more panels and connecting them in parallel with the two panels that already in the

model and see the change on the output AC power of the model.

At this experiment the efficiency of the DC-AC converter would be assumed to be a fixed 98 percent. And would get three results of the output AC power.

1. Two Solar Panels with DC-AC converter Efficiency 98%.
2. Three Solar Panels with DC-AC converter Efficiency 98%.
3. Four Solar Panels with DC-AC converter Efficiency 98%.

IV. RESULTS OF MATLAB™ PHOTOVOLTAIC GENERATERMODEL

DC-AC Converter Efficiency

1. When the DC-AC converter Efficiency is 80% we would get the next result for the output AC power.

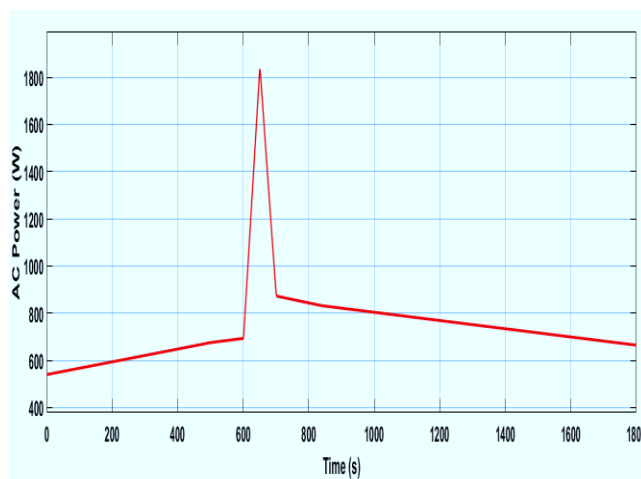

Fig 3 AC Power with DC-AC converter Efficiency is 80%

2. When the DC-AC converter Efficiency is 90% we would get the next result for the output AC power.

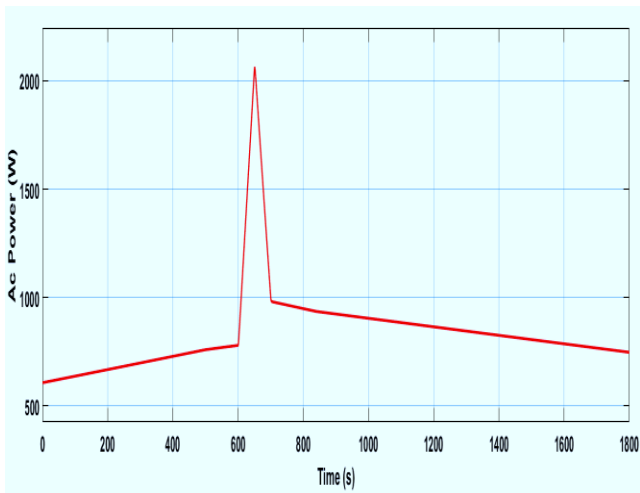

Fig 4 AC Power with DC-AC converter Efficiency is 90%

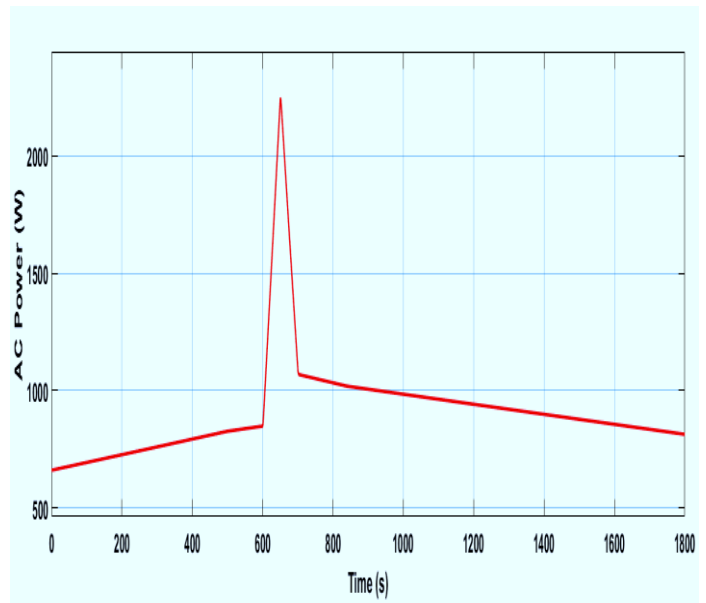

Fig 5 Two Solar Panels with DC-AC converter Efficiency 98%.

3. When the DC-AC converter Efficiency is 98% we would get the next result for the output AC power.

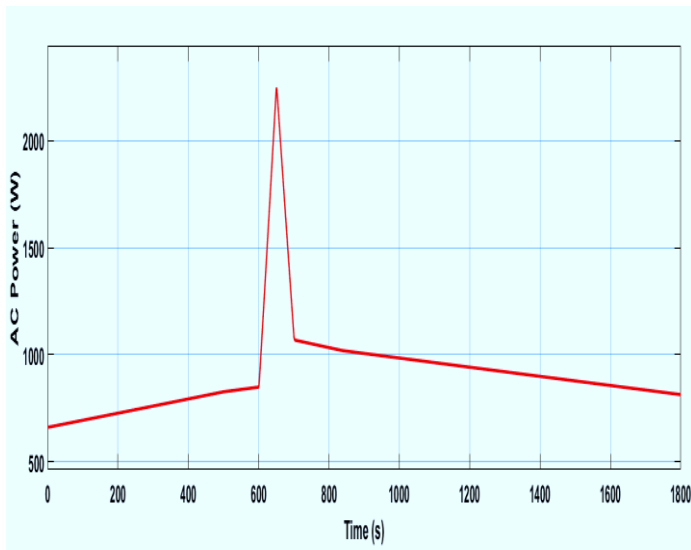

Fig 4 AC Power with DC-AC converter Efficiency is 98%

- The result of AC power of the model for the three DC-AC converter Efficiency can be shown in the figure 5.

B. The number of solar panels

1. Two Solar Panels with DC-AC converter Efficiency 98%.

2. Three Solar Panels with DC-AC converter Efficiency 98%.

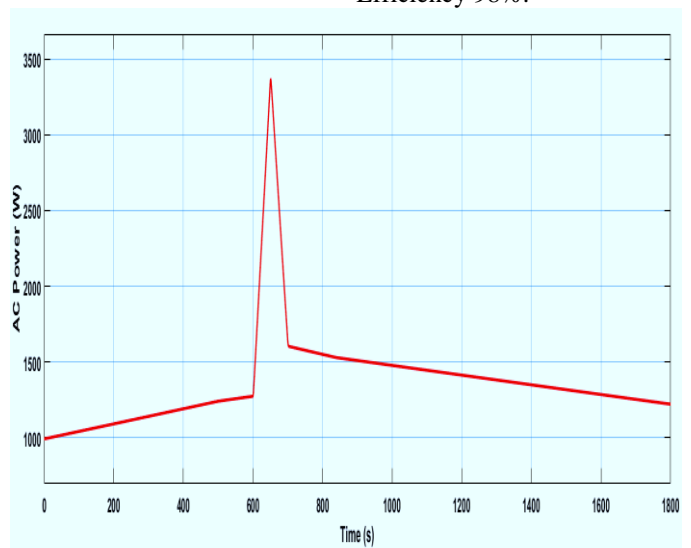
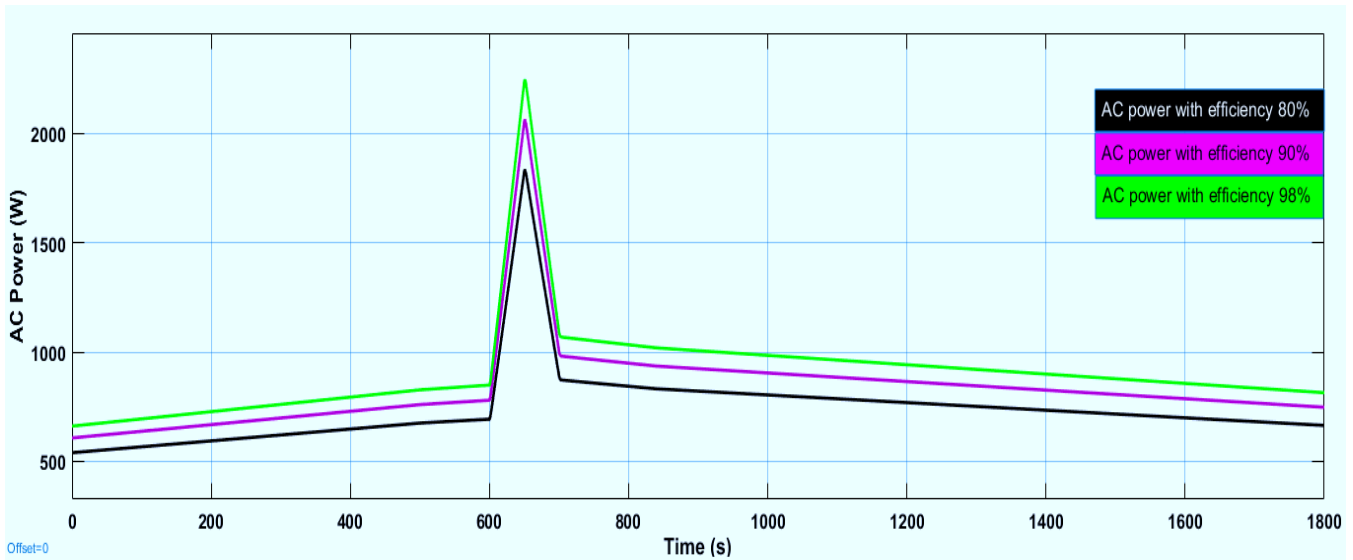

Fig 6 Three Solar Panels with DC-AC converter Efficiency 98%.

3. Four Solar Panels with DC-AC converter Efficiency 98%.



So the combined Final results for experiment for each DC-AC

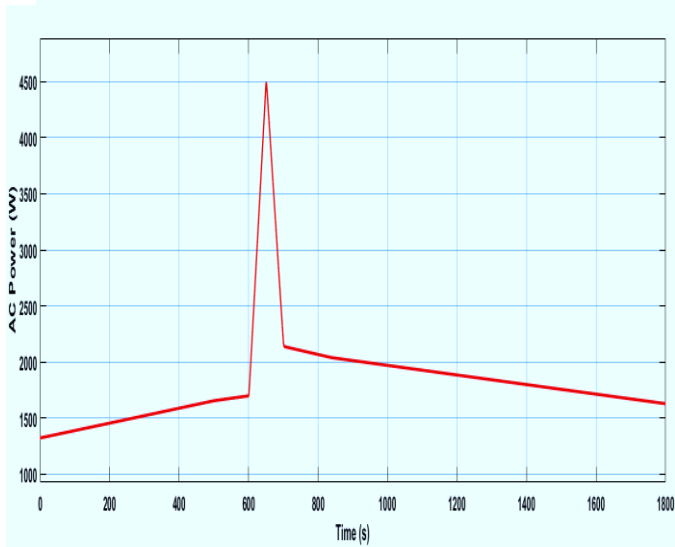
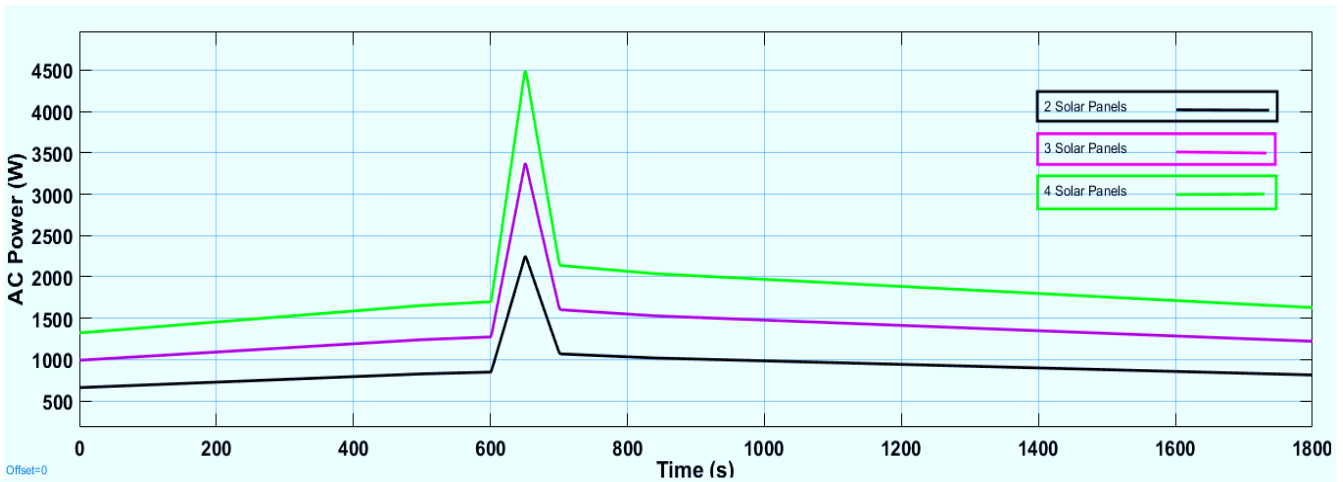

Fig 7 Four Solar Panels with DC-AC converter Efficiency 98%.

converter Efficiency, and the number of Solar panels can be shown as bellow on figure 8 and figure 9

- Fig8 Matlab P-V curves for various DC-AC Efficiency
- Fig. 9 Matlab P-V curves for various Solar panels sets.

So, from the previous results we can summarize the following:

- 1) We can clearly see the effect of the efficiency of the DC-AC converter on the output power. A higher Converter efficiency will give us higher output power means a higher Photovoltaic Generator system efficiency.
- 2) More solar panels means more output power, when installing more solar panels the produced electric energy would rise and we will get more AC power at the output.

V. CONCLUSIONS

An accurate PV module electrical model is presented and demonstrated in Matlab for a typical solar panel, the model is tested by varying the irradiance which approximates the effect of varying cloud cover. Power generation steps immediately following the irradiance change. Environmental temperature also varies during the test. Finally the model development was used to show the effect of: DC-AC converter efficacy, number of solar panels.

This paper shows the effect of some parameters that effect the output power of the P-V system to develop a complete solar photovoltaic power electronic conversion with higher power.

References

- [1] L.D. Partain, Solar Cells and Their Applications, John Wiley & Sons, New York, 1995.
- [2] M.R. Patel, Wind and Solar Power Systems, CRC Press, 1995.
- [3] Eduardo Lorenzo (1994). Solar Electricity: Engineering of Photovoltaic Systems. Progensa. ISBN
- [4] J. Clerk Maxwell, A Treatise on Electricity and Magnetism, 3rd ed., vol. 2. Oxford: Clarendon, 1892, pp.68-73.